

horexkal



TOWER

ALR ALR 977 - ALR 1250 - ALR 1879

ALRN ALRN 977 - ALRN 1250 - ALRN 1879

ALRS ALRS 655 - ALRS 977 - ALRS 1250

ALAS ALAS 655 - ALAS 977 - ALAS 1250

ALA ALA 977 - ALA 1290 - ALA 1879

ALAL ALAL 977 - ALAL 1290 - ALAL 1879



Tablas / Chart / Table

TOWER		ALR			ALRN			ALRS			ALAS			ALA			ALAL		
MODELO/ MODEL/ MODÈLE		ALR 977	ALR 1250	ALR 1879	ALRN 977	ALRN 1250	ALRN 1879	ALRS 655	ALRS 977	ALRS 1250	ALAS 655	ALAS 977	ALRS 1250	ALA 977	ALA 1290	ALA 1879	ALAL 977	ALAL 1290	ALAL 1879
Superficie exp. Surface exp. Surface exp.	m2	1,17	2,21	3,15	1,17	2,21	3,18	0,81	1,16	1,62	1,04	1,68	2,51	1,2	1,62	2,4	1,2	1,62	2,4
Pot. frigorífica Refrigeration power Puis frigorifique	(-10°C/+45°C) W	550	875	1250	/			780	1340	1900	780	1340	1900	550	875	1250	550	875	1250
Pot. eléctrica Electrical power Pot electricque	W	679	1045	1358	9	14	21	780	1340	1900	780	1340	1900	1192	1526	1970	1192	1526	1970
Temp. producto Product temp. Temp. produit	°C	1 / +10			N			+65°C			+65°C			0/+5°C			0/+9°C		
Peso/ Weight/ Poids	Kg	130	190	260	108	156	248	115	150	190	115	150	190	200	223	310	200	223	310
Dim. C/emb. (LxPxX) Dim With packaging (WxHxD)	mm	1000 x 1000 x 1401	1300 x 1000 x 1401	2000 x 1000 x 1401	1000 x 1000 x 1401	1300 x 1000 x 1401	2000 x 1000 x 1401	725 x 1000 x 1401	1000 x 1000 x 1401	1300 x 1000 x 1401	725 x 1000 x 1401	1000 x 1000 x 1401	1300 x 1000 x 1401	1000 x 1000 x 1401	1300 x 1000 x 1401	2000 x 1000 x 1401	1000 x 1000 x 1401	1300 x 1000 x 1401	2000 x 1000 x 1401
Dim Avec emballage (WxHxD)		1401	1401	x 1401	1401	1401	x 1401	1401	1401	1401	1401	1401	1401	1401	1401	1401	x 1401	1401	1401

Características / Features / Caractéristiques























● Optional

Secciones / Sections / Sections

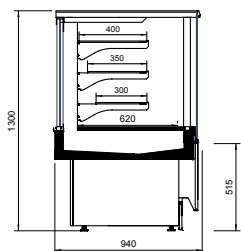

ALRN

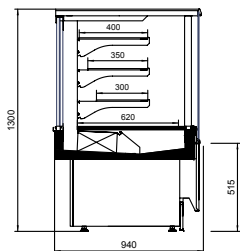

ALR

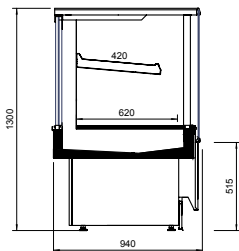

ALRS

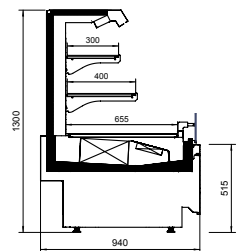

ALA

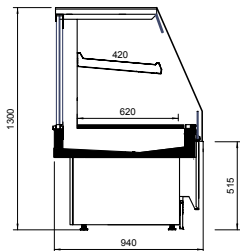

ALAS

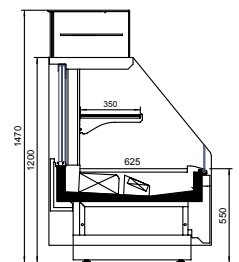

ALAL MIX

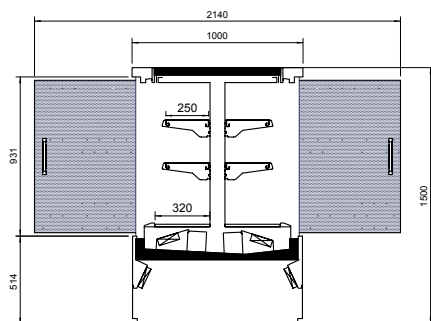

QBIC-L



Características / Features / Caractéristiques



REFRIGERADO
COOL
FROID



CALIENTE
HOT
CHAUD



NEUTRO
NEUTRAL
NEUTRE

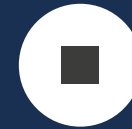

PRO
PRO
PRO



CONGELACIÓN
FREEZING
CONGÉLATION

Características / Features / Caractéristiques

 <p>660x400</p> <p>Exposición pintada Painted Exhibition Exposition Peinte 660x400</p>	 <p>760x625</p> <p>Exposición pintada Painted Exhibition Exposition Peinte 760x625</p>	 <p>Cuerpo Inyectado Injected Body Corps injecté 40kgs cm³</p>	 <p>660x400</p> <p>Almacen/ Reserva refrigerada capacity refrigerated storage Réserve réfrigérée de capacité 660x400</p>	 <p>Patas regulables en altura Height adjustable feet Pieds réglables en hauteur</p>	 <p>Bancada de motor extraíble Removable compressor set system Système de compresseur amovible</p>	 <p>Control electrónico Electronic control Contrôle électronique</p>	<p>R-290</p> <p>Gas refrigerante Cooling Gas Gaz de refroidissement R-290</p>	<p>R-452</p> <p>Gas refrigerante Cooling Gas Gaz de refroidissement R-452</p>
 <p>Bandeja evaporativa alta eficiencia High efficiency evaporative tray Bac évaporatif à haute efficacité</p>	 <p>Sistema frigorífico Dinámico Dynamic Refrigeration System Système de réfrigération dynamique</p>	 <p>Abatible con sistema de retención Folding with retention system Pliage avec système de rétention</p>	 <p>Termómetro Digital Digital thermometer Thermomètre numérique</p>	 <p>Cierre seguridad Security lock Verre sécurisé</p>	 <p>Cristal securizado Securized glass Verre sécurisé</p>	 <p>1 estante cristal securizado 1 secured glass shelf 1 étagère en verre sécurisée</p>	 <p>2 estante cristal securizado 2 secured glass shelf 2 étagère en verre sécurisée</p>	 <p>Mueble sin estructura Furniture without structure Meubles sans structure</p>
 <p>Iluminación premium Premium Lighting Premium Éclairage LED 4000K</p>	 <p>Anticondensación alta eficiencia High efficiency anti-condensation Haute efficacité anti-condensation</p>	 <p>Anticondensación por resistencias Anti condensation by resistors Anti condensation par résistances</p>	 <p>Cajonera superior trasera Top rear chest of drawers Habillage supérieure arrière</p>	 <p>Cajonera inferior trasera Lower rear chest of drawers Habillage inférieur arrière</p>	 <p>Ampliación encimera Worktop extension Extension de plan de travail</p>	 <p>Iluminación extra Extra Lighting Extra Éclairage</p>	 <p>Selección color epoxi exterior External epoxy color selection Sélection de couleur externe epoxy</p>	 <p>Selección color epoxi interior (certificado sanitario) Interior epoxy color selection (sanitary certificate) Choix de couleur intérieur époxy (certificat sanitaire)</p>
 <p>Encimera de trabajo acero Aisi 304 Aisi 304 steel worktop Plan de travail en acier Aisi 304</p>	 <p>Clase Climática 3 Climate class 3 Classe climatique 3 - 25°C 60 Hr</p>	 <p>Grupo remoto Remote Groupe distant</p>	 <p>Conexión eléctrica Electrical connection Branchement électrique 220v 50hz</p>	 <p>Evaporador con pintura e-poxy Evaporator with e-poxy paint Évaporateur avec peinture e-poxy</p>	 <p>Ventiladores de Alta-Eficiencia High Efficiency Fans Ventilateurs Haute Efficacité</p>	 <p>Puertas correderas (en metacrilato) Sliding doors (in methacrylate) Portes coulissantes (en méthacrylate)</p>		

TOWER

